

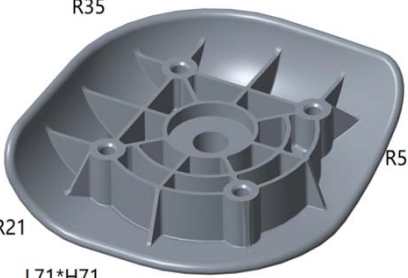







# 东莞市励骏高分子材料有限公司

## 轮壳目录

 <p>R35 R55 R21 L71*H71</p>	 <p>3-R15 / 3-R22 L71*H71</p>	 <p>R27 L75*H59</p>
<p>T01 (PP) 轮壳 R+L 内盖</p>	<p>T02-R15/22轮壳 (PP)</p>	<p>T03 (PP) R+L 轮壳 有压条 布箱</p>
 <p>L247*H190</p>	 <p>3-R35 L75*H75</p>	 <p>3-R35 L77*H77</p>
<p>T04延伸架 (PP)</p>	<p>T05 (PP) 轮壳 内盖</p>	<p>T05B (PP) 轮壳 内盖</p>
 <p>H73*H117 R40</p>	 <p>R40 L70*H67</p>	 <p>R60 R40 R30 L81*H81</p>
<p>T06 (PP) 轮壳 R+L 内盖+压条 布箱</p>	<p>T07/T07B (PP) 轮壳 R+L 内盖 布箱</p>	<p>T08 (PP) 轮壳 R+L 内盖</p>

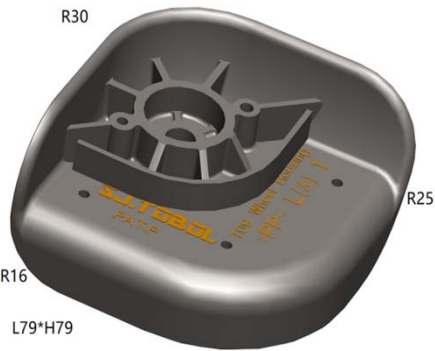
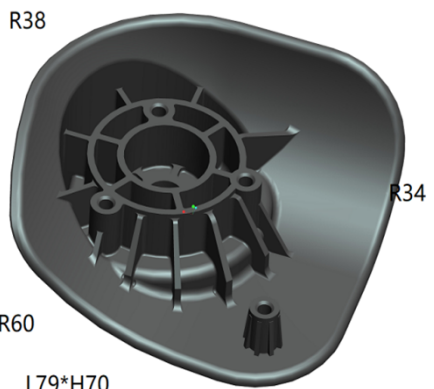

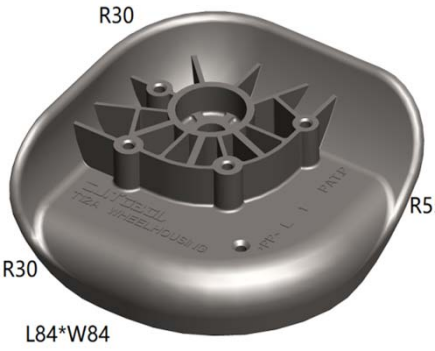
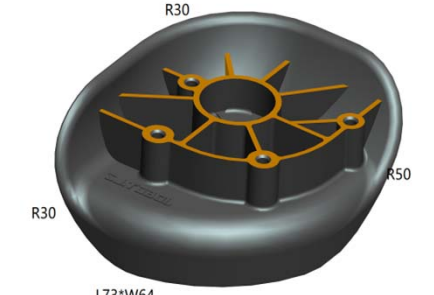
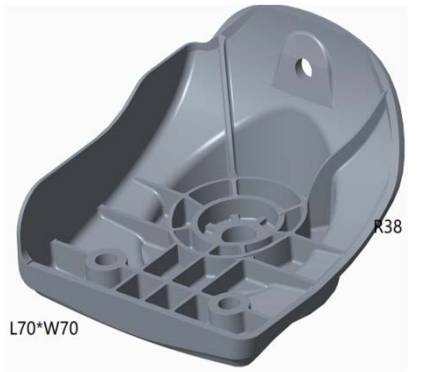

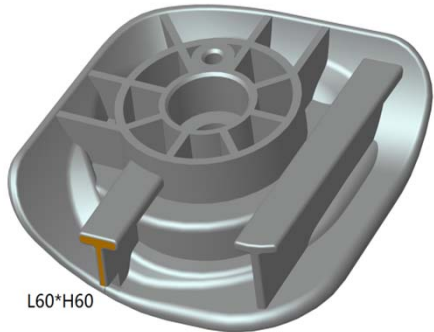
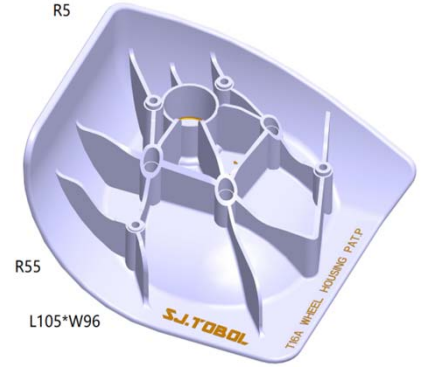

# 东莞市励骏高分子材料有限公司

## 轮壳目录

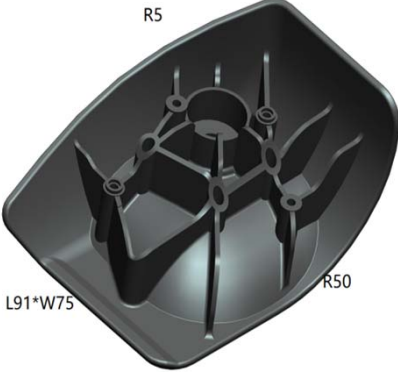
 <p>R30 R25 R16 L79*H79</p>	 <p>R38 R34 R60 L79*H70</p>	 <p>R38 R46 L61*H61</p>
<p>T09 (PP) 轮壳 R+L 内盖</p>	<p>T10 (PP) 轮壳 R+L 内盖</p>	<p>T11 (PP) 轮壳 R+L 内盖</p>
 <p>R30 R55 R30 L84*W84</p>	 <p>R30 R50 R30 L73*W64</p>	 <p>R38 L70*W70</p>
<p>T12A (PP) 轮壳 R+L 内盖</p>	<p>T12B (PP) 轮壳 R+L 内盖</p>	<p>T13 (PP) 轮壳 R+L 布箱</p>
 <p>L60*H60</p>	 <p>L60*H60</p>	 <p>R5 R55 L105*W96</p>
<p>T13B (PP) 轮壳 R+L 布箱</p>	<p>T15 (PP) 轮壳 R+L</p>	<p>T16A (PP) 轮壳 R+L</p>

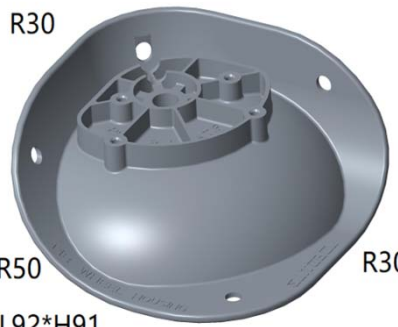
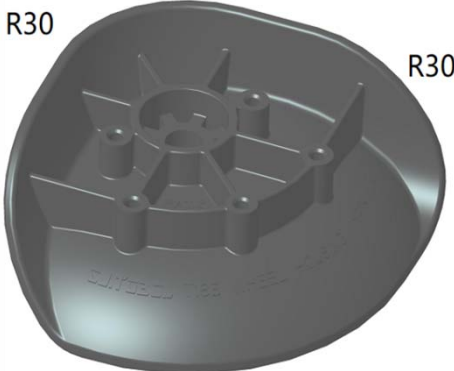

# 东莞市励骏高分子材料有限公司

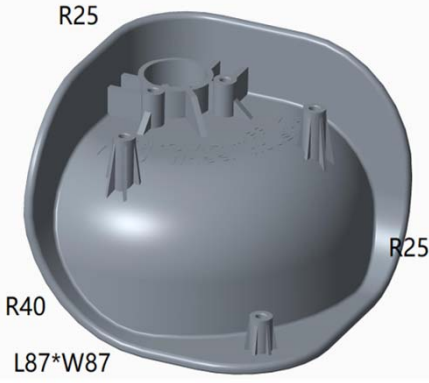
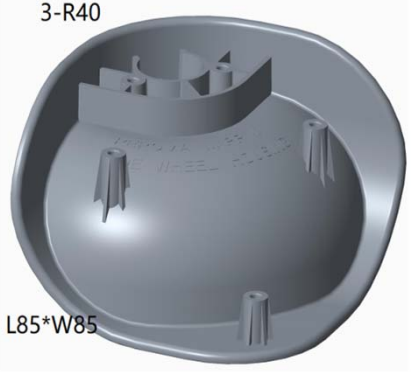
## 轮壳目录

 <p>R5 L91*W75 R50</p>	 <p>3-R28 L83*H83</p>	 <p>R30 R30 R30 L92*H91</p>
<p>T16B (PP) 轮壳 R+L</p>	<p>T17 (PP) 轮壳 配底盘</p>	<p>T18A (PP) 轮壳 R+L</p>
 <p>R30 R30 L80*H76</p>	 <p>3-R40 L94*W94</p>	 <p>3-R40 L94*W94</p>
<p>T18B (PP) 轮壳 R+L 内盖</p>	<p>T19A (PP) 轮壳 内盖</p>	<p>T19B (PA) 轮壳</p>
 <p>3-R40 L85*W85</p>	 <p>R25 R25 R40 L87*W87</p>	 <p>3-R40 L85*W85</p>
<p>T19C (PA) 轮壳</p>	<p>T19D (PP) 轮壳 R+L 内盖</p>	<p>T19E (PP) 轮壳 内盖</p>



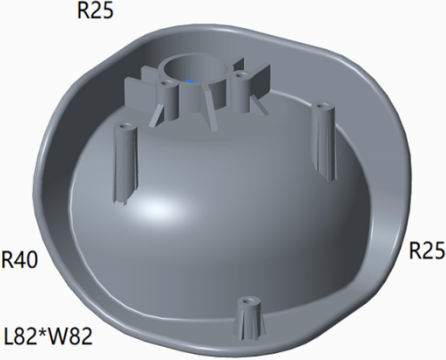
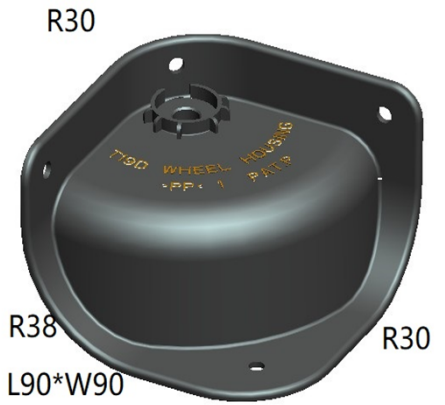
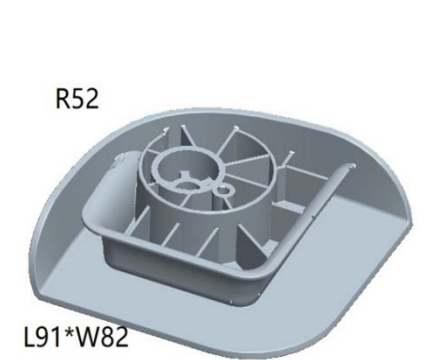

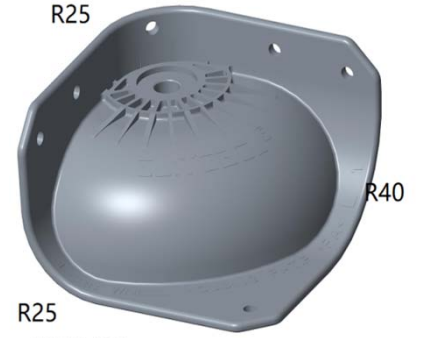
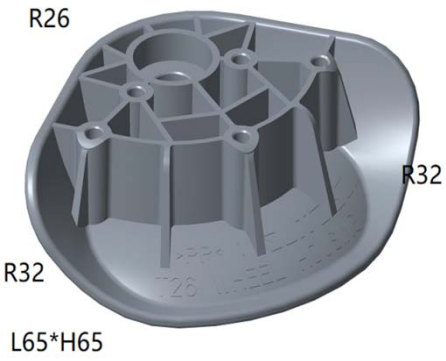
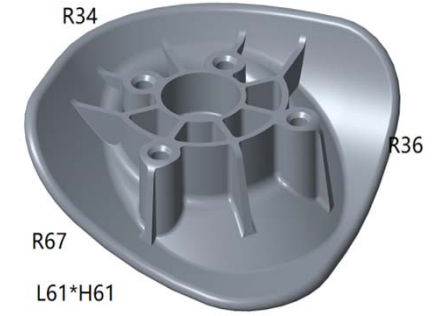
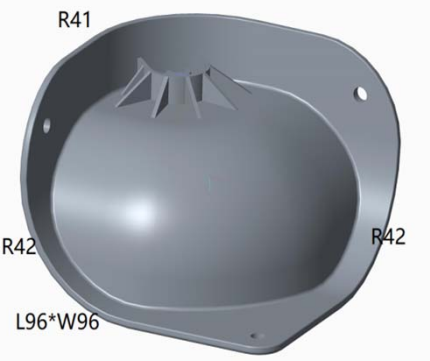

# 东莞市励骏高分子材料有限公司

## 轮壳目录

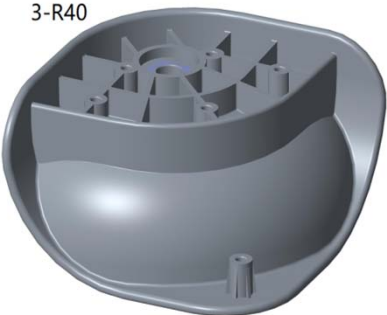
 <p>R25 R40 L82*W82</p>	 <p>R30 R38 L90*W90</p>	 <p>R52 L91*W82</p>
<p>T19F (PP) R+L 轮壳 内盖</p>	<p>T20 (PA) R+L 轮壳</p>	<p>T22A (PP) 轮壳 R+L PP箱</p>
 <p>R32 L80*W69</p>	 <p>R25 R40 L92*W92</p>	 <p>R25 R40 L85*H85</p>
<p>T22B (PP) 轮壳 R+L PP箱</p>	<p>T23A (PA) 轮壳 R+L</p>	<p>T23B (PA) 轮壳 R+L</p>
 <p>R26 R32 L65*H65</p>	 <p>R34 R36 L61*H61</p>	 <p>R41 R42 L96*W96</p>
<p>T26 (PP) 轮壳 内盖</p>	<p>T28/T28A/T28C (PP) R+L 内盖</p>	<p>T29A (PA) 轮壳</p>

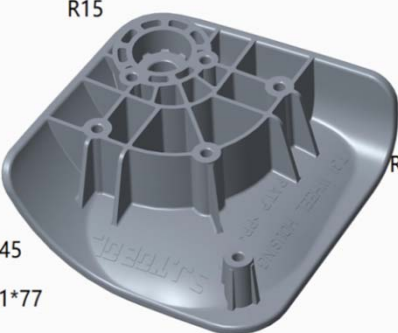

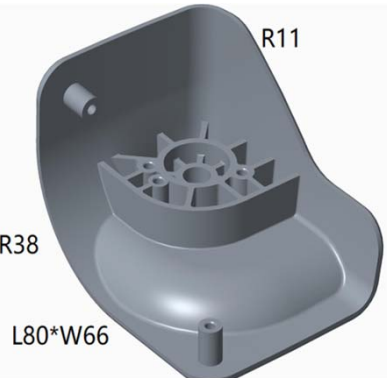

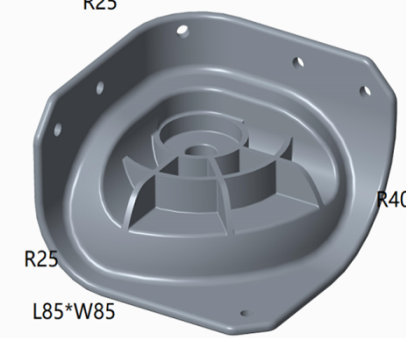
# 东莞市励骏高分子材料有限公司

## 轮壳目录

 <p>3-R40</p> <p>L86*H86</p>	 <p>3-R40</p> <p>L92*W92</p>	 <p>3-R40</p> <p>L89*W89</p>
<p>T29B (PP) 轮壳 L+R</p>	<p>T30A (PP) 轮壳 R+L 内盖</p>	<p>T30B (PP) 轮壳 R+L 内盖</p>
 <p>R15</p> <p>R15</p> <p>R45</p> <p>81*77</p>	 <p>R10</p> <p>L84*W82</p>	 <p>3-R10</p> <p>L84*W78</p>
<p>T31 (PP) 轮壳 R+L</p>	<p>T32A (PP) 轮壳 R+L 内盖</p>	<p>T32B (PP) 轮壳 R+L 内盖</p>
 <p>R11</p> <p>R38</p> <p>L80*W66</p>	 <p>R25</p> <p>R40</p> <p>R25</p> <p>L92*W92</p>	 <p>R25</p> <p>R40</p> <p>R25</p> <p>L85*W85</p>
<p>T33 (PP) 轮壳 R+L 内盖</p>	<p>T36A (PA6) 轮壳 (R+L)</p>	<p>T36B (PA6) 轮壳 L+R</p>

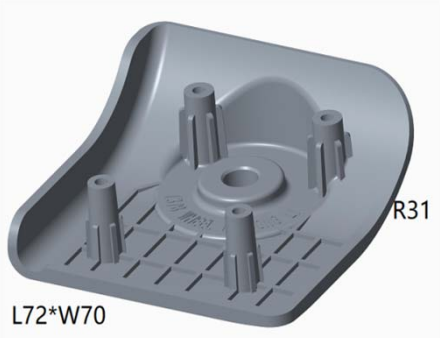

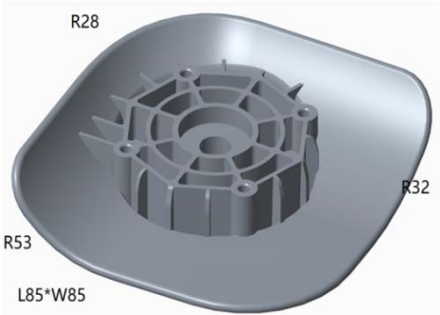
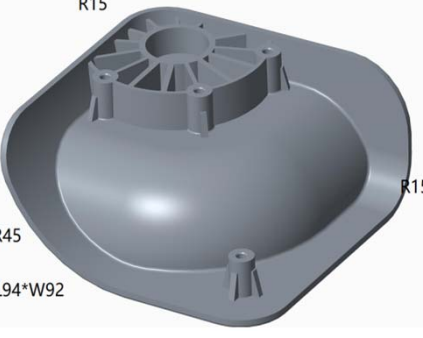

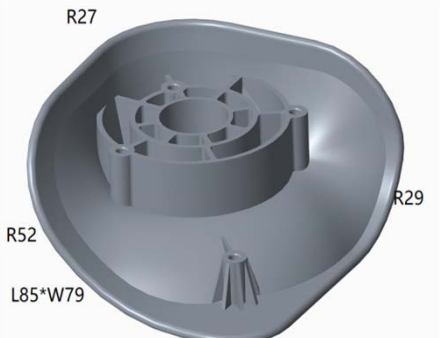
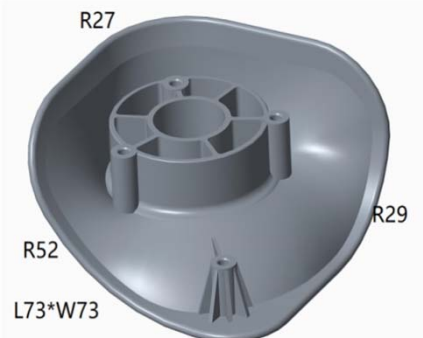
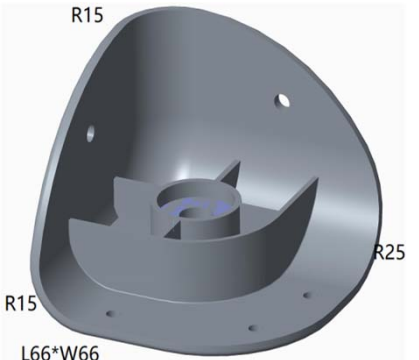
# 东莞市励骏高分子材料有限公司

## 轮壳目录

 <p>L72*W70 R31</p>	 <p>H95*W72 R39</p>	 <p>L70*W68 R42</p>
<p>T37轮壳 (PP) R+L 内盖</p>	<p>T38轮壳 (PP) R+L 内盖</p>	<p>T39轮壳 (PP) R+L 内盖</p>
 <p>R28 R53 R32 L85*W85</p>	 <p>R15 R45 R15 L94*W92</p>	 <p>R31 R49 R31</p>
<p>T40轮壳 (PP) R+L</p>	<p>T41轮壳 (PP) R+L</p>	<p>T42轮壳 (PP) R+L</p>
 <p>R27 R52 R29 L85*W79</p>	 <p>R27 R52 R29 L73*W73</p>	 <p>R15 R15 R25 L66*W66</p>
<p>T43A轮壳 (PP) R+L</p>	<p>T43B轮壳 (PP) R+L</p>	<p>T45轮壳 (PP) R+L</p>

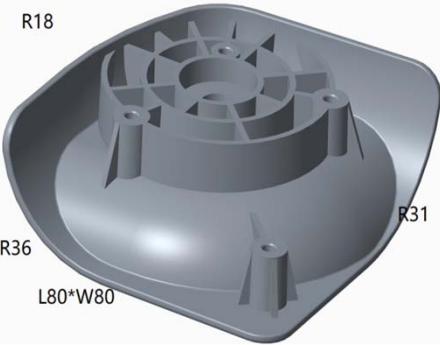

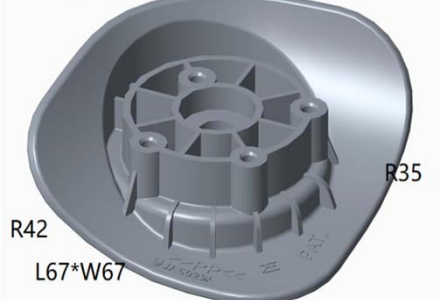
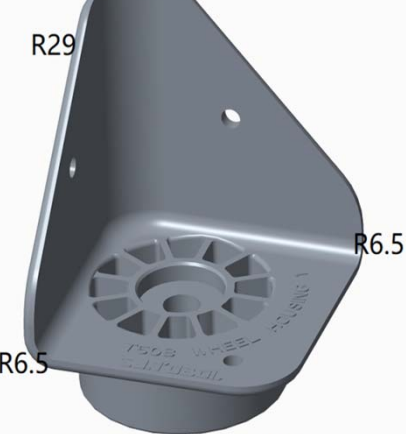
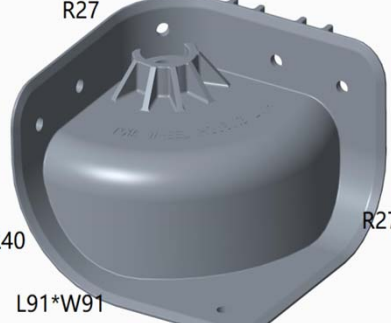
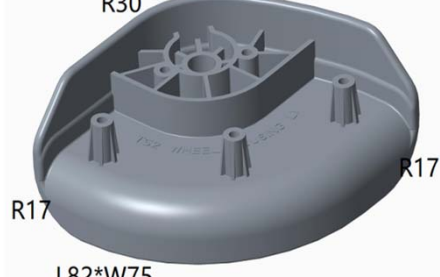

# 东莞市励骏高分子材料有限公司

## 轮壳目录

		
<p style="text-align: center;">T46轮壳 (PP) R+L 内盖</p>	<p style="text-align: center;">T47轮壳 (PA) R+L</p>	<p style="text-align: center;">T48轮壳 (PP)</p>
		
<p style="text-align: center;">T49轮壳 (PP) R+L</p>	<p style="text-align: center;">T50A, B轮壳 (PP) R+L</p>	<p style="text-align: center;">T51A轮壳 (PP) R+L</p>
		
<p style="text-align: center;">T52轮壳 (PP) R+L</p>	<p style="text-align: center;">T53轮壳 (PP) R+L</p>	<p style="text-align: center;">T54轮壳 (PP)</p>

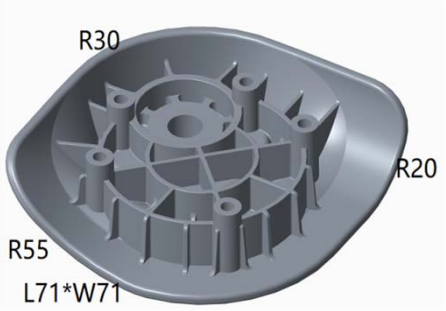
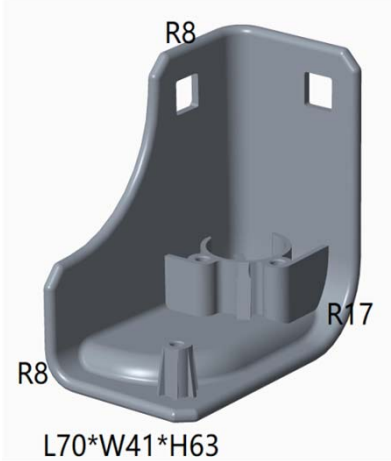
# 东莞市励骏高分子材料有限公司

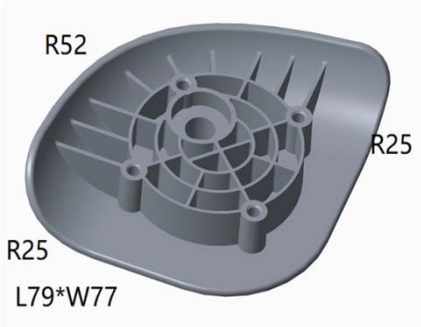
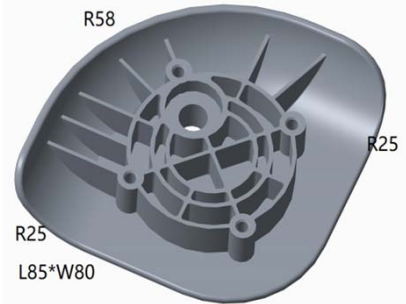
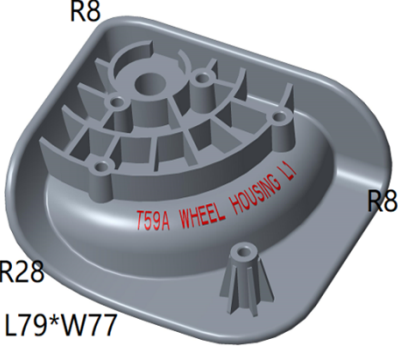
## 轮壳目录

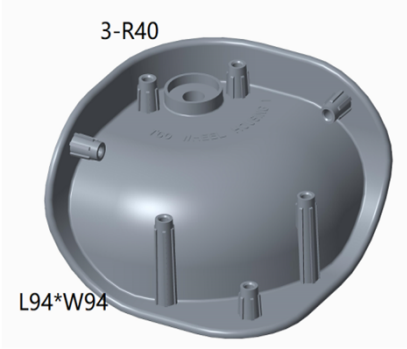
 <p>R30 R20 R55 L71*W71</p>	 <p>R8 R17 R8 L70*W41*H63</p>	 <p>3-R40 L93*W93</p>
<p>T55轮壳(PP) R+L</p>	<p>T56轮壳(PP) R+L</p>	<p>T57A轮壳(P)</p>
 <p>3-R40 L89*W89</p>	 <p>R52 R25 R25 L79*W77</p>	 <p>R58 R25 R25 L85*W80</p>
<p>T57B轮壳(PP)</p>	<p>T58A轮壳(PP) R+L</p>	<p>T58B轮壳(PP) R+L</p>
 <p>R8 R28 L79*W77 T59A WHEEL HOUSING LI</p>	 <p>R8 R28 R8 L77*W69 T59B WHEEL HOUSING PI</p>	 <p>3-R40 L94*W94</p>
<p>T59A轮壳(PP) R+L 内盖</p>	<p>T59B轮壳(PP) R+L 内盖</p>	<p>T60轮壳(PA) 内盖</p>

# 东莞市励骏高分子材料有限公司

## 轮壳目录

 <p>R28 R38 R28 L86*W86</p>	 <p>R28 R43 R28 L96*W94</p>	 <p>R40 R40 R40 L76*W70</p>
<p style="text-align: center;">T61A轮壳 (PA) R+L</p>	<p style="text-align: center;">T61B轮壳 (PA) R+L</p>	<p style="text-align: center;">T62轮壳 (PP) R+L</p>
 <p>R13 R45 R13 L94*W51</p>	 <p>3-R18 L78*W78</p>	 <p>3-R18 L78*W78</p>
<p style="text-align: center;">T65轮壳 (PP) R+L 内盖</p>	<p style="text-align: center;">T66轮壳 (PP)</p>	<p style="text-align: center;">T67轮壳 (PP)</p>
 <p>3-R40 L95*W95</p>	 <p>R15 R25 R25 L77*W77</p>	 <p>R35 R35 R44 L90*W83</p>
<p style="text-align: center;">T68轮壳 (PP)</p>	<p style="text-align: center;">T69轮壳 (PP) 内盖</p>	<p style="text-align: center;">T70轮壳 (PP) 内盖</p>





# 东莞市励骏高分子材料有限公司

## 轮壳目录

<p style="text-align: center;">T72轮壳 (PP) R+L</p>	<p style="text-align: center;">T73轮壳 (PA)</p>	<p style="text-align: center;">T74轮壳 (PA)</p>
<p style="text-align: center;">T75轮壳 (PP) 2L+2R</p>	<p style="text-align: center;">T76轮壳 (PA) 2L+2R</p>	<p style="text-align: center;">T76A轮壳 (PA) 2L+2R</p>
<p style="text-align: center;">T76B轮壳 (PA) 2L+2R</p>	<p style="text-align: center;">T77轮壳 (PA) 2L+2R 内盖</p>	<p style="text-align: center;">T77H轮壳 (PA) 2L+2R 内盖</p>

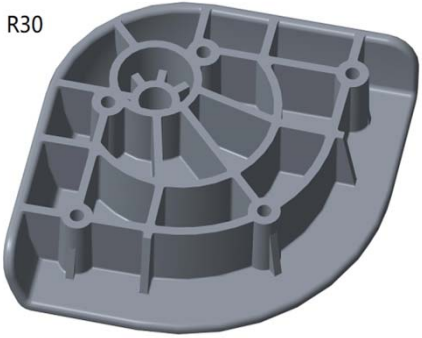
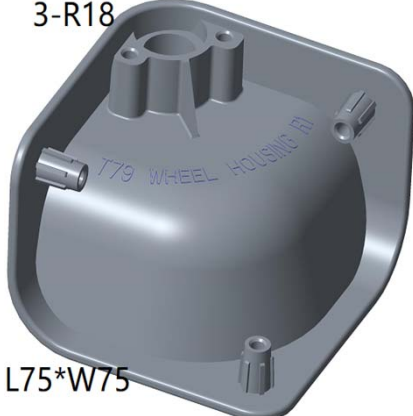
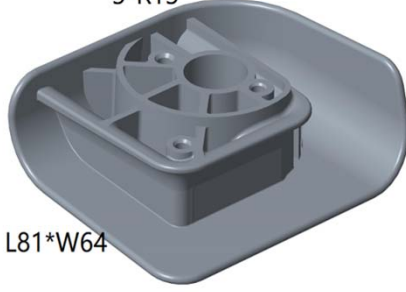
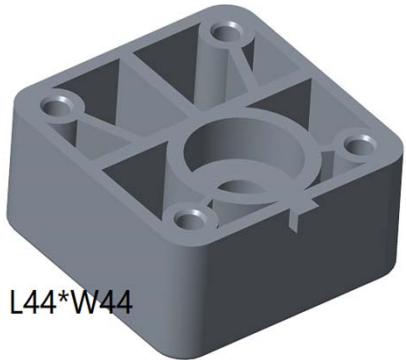
# 东莞市励骏高分子材料有限公司

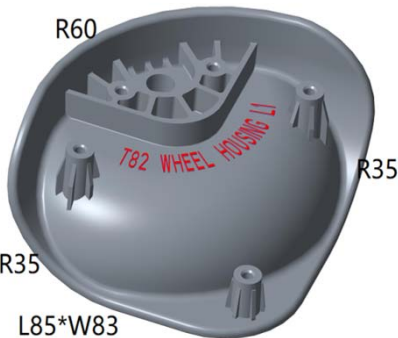
## 轮壳目录

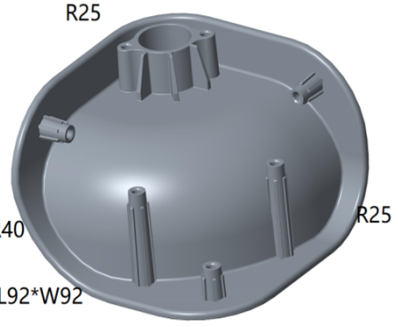
 <p>R30</p> <p>L86*W86</p>	 <p>3-R18</p> <p>T79 WHEEL HOUSING R1</p> <p>L75*W75</p>	 <p>3-R13</p> <p>L81*W64</p>
<p>T78轮壳(PA) 2L+2R</p>	<p>T79轮壳(PA)</p>	<p>T80A轮壳(PP) 2L+2R</p>
 <p>L44*W44</p>	 <p>R15</p> <p>R15</p> <p>R45</p> <p>T81 WHEEL HOUSING L1</p> <p>L81*W77</p>	 <p>3-R18</p> <p>T75 WHEEL HOUSING 1</p> <p>L82*W82</p>
<p>T80B轮壳(PP) 2L+2R</p>	<p>T81轮壳(PP) 2L+2R</p>	<p>T115轮壳(PP) 2L+2R</p>
 <p>R60</p> <p>T82 WHEEL HOUSING L1</p> <p>R35</p> <p>R35</p> <p>L85*W83</p>	 <p>R60</p> <p>T83 WHEEL HOUSING L1</p> <p>R35</p> <p>R35</p> <p>L93*W93</p>	 <p>R25</p> <p>R40</p> <p>L92*W92</p>
<p>T82轮壳(PP) 2L+2R 内盖</p>	<p>T83轮壳(PP) 2L+2R 内盖</p>	<p>T85轮壳(PA) L+R 内盖</p>

# 东莞市励骏高分子材料有限公司

## 轮壳目录

<p style="text-align: center;">T86轮壳(PA) L+R</p>	<p style="text-align: center;">T87轮壳PA (L+R)</p>	<p style="text-align: center;">T87A轮壳(PA) L+R</p>
<p style="text-align: center;">T88轮壳(PA) L+R 内盖</p>	<p style="text-align: center;">T89轮壳(PP) 2L+2R 内盖</p>	<p style="text-align: center;">T90轮壳(PA) 2L+2R</p>
<p style="text-align: center;">T93轮壳(PP) 2L+2R 内盖</p>	<p style="text-align: center;">T94轮壳(PP) 2L+2R 内盖</p>	<p style="text-align: center;">T95轮壳(PP) 2L+2R 内盖</p>

# 东莞市励骏高分子材料有限公司

## 轮壳目录

 <p>R18 R18 R30 L67*W67 L1</p>	 <p>R24 R30 R35 L70*W70</p>	 <p>L68*W40</p>
<p>T96轮壳(PP) 2L+2R 内盖</p>	<p>T97轮壳(PP) 2L+2R 内盖</p>	<p>T98内轮壳(PP) 2L+2R 内盖</p>
 <p>R36 L58*W47</p>	 <p>3-R18 T100 WHEEL HOUSING R1 L90*W90</p>	 <p>R60 R8 R8 L87*W87</p>
<p>T99轮壳(PA) 2L+2R 内盖</p>	<p>T100轮壳(PA) 1*2 内盖</p>	<p>T101轮壳(PA) 2L+2R 内盖</p>
 <p>R20 R56 R18 97*W97 T102 WHEEL HOUSING</p>	 <p>R20 R56 R18 L77*W75</p>	 <p>R30 R35 R35 L60*W60</p>
<p>T102轮壳(PP) 2L+2R 内盖</p>	<p>T102b轮壳(PP) 2L+2R 内盖</p>	<p>T103轮壳(PP) 2L+2R 内盖</p>

# 东莞市励骏高分子材料有限公司

## 轮壳目录

 <p>R30</p> <p>L61*W61</p>	 <p>3-R35</p> <p>L75*W75</p>	 <p>R5</p> <p>R5</p> <p>L66*W66</p>
<p>T105轮壳 (PP) 2L+2R</p>	<p>T106轮壳 (PP) 2L+2R</p>	<p>T107轮壳 (PP) 2L+2R 内盖</p>
 <p>R20</p> <p>R30</p> <p>R20</p> <p>L78*W68</p>	 <p>R80</p> <p>L109*W52</p>	 <p>R10</p> <p>R35</p> <p>R10</p>
<p>T108内轮壳 (PP) 2L+2R</p>	<p>T109轮壳 (PP) 2L+2R</p>	<p>T110轮壳 (PP) 2L+2R 内盖</p>
 <p>R30</p> <p>R25</p> <p>R16</p> <p>L79*W79</p>	 <p>R5</p> <p>R24</p> <p>R5</p> <p>L76*W76</p>	 <p>R15</p> <p>R17</p> <p>L72*W72</p>
<p>T111轮壳 (PP) 2L+2R 内盖</p>	<p>T113轮壳 (PP) 2L+2R</p>	<p>T113B轮壳 (PP) 2L+2R</p>

# 东莞市励骏高分子材料有限公司

## 轮壳目录

 <p>R30</p> <p>L6*W69</p>	 <p>R37</p> <p>R20</p> <p>R20</p> <p>L84*W84</p>	 <p>3-R19</p> <p>T118 WHEEL HOUSING LJ</p> <p>L78*W78</p>
<p>T116轮壳 (PP) 2L+2R</p>	<p>T117 (PA)</p>	<p>T118轮壳 (PA+纤) 2L+2R 内盖</p>
	 <p>R17</p> <p>R64</p> <p>R17</p> <p>L83*W80</p>	 <p>R40</p> <p>R25</p> <p>R25</p> <p>L98*W91</p> <p>T121</p>
<p>T119轮壳 (PA+纤) 2L+2R 内盖</p>	<p>T120轮壳 (PP) 2L+2R 内盖</p>	<p>T121轮壳 (PA) 2L+2R</p>
 <p>3-R30</p> <p>L82*W68</p>	 <p>3-R30</p> <p>L67*W42</p>	 <p>R43</p> <p>L88*W81</p>
<p>T122 (PP) 轮壳 L+R 内盖</p>	<p>T123 (PP) 轮壳 L+R 内盖</p>	<p>T124 (PP) 轮壳 L+R 内盖</p>

# 东莞市励骏高分子材料有限公司

## 轮壳目录

 <p>L88*W80 R43</p>	 <p>R60 R18 R18 L1 T126 M/PP L75*W68</p>	 <p>R35 R29 L85*W72</p>
<p>T125(PP) 轮壳 L+R 内盖</p>	<p>T126(PP) 轮壳 L+R 内盖</p>	<p>T127(PP) 轮壳 L+R 内盖</p>
 <p>R44 R49 R68 L78*W66</p>	 <p>R53 R18 R18 L90*W90</p>	 <p>R35 R8 R8 L66*W66 T130 WHEEL HOUSING</p>
<p>T128轮壳 (PP) 2L+2R</p>	<p>T129轮壳 (PP) 2L+2R</p>	<p>T130轮壳 (PP) 2L+2R</p>
 <p>R5 R15 R25 L70*W70</p>	 <p>R25 R25 R51 L75*H72</p>	 <p>R25 R26 R30 L85*H82</p>
<p>T131轮壳 (PP) 2L+2R</p>	<p>T132轮壳 (PP) 2L+2R 有内盖</p>	<p>T133轮壳 (PP) 2L+2R</p>

# 东莞市励骏高分子材料有限公司

## 轮壳目录

<p>3-R20</p>  <p>L65*H65</p>		<p>3-R20</p>  <p>L83*H83</p>
<p>T134轮壳 (PA)</p>	<p>T135轮壳 (PP) 2L+2R 有内盖</p>	<p>T136轮壳 (PP)</p>
<p>R28</p>  <p>L60*H50</p>		
<p>T138轮壳 (PP) 2L+2R 有内盖</p>	<p>T139轮壳 (PA) 2L+2R 有内盖</p>	<p>141轮壳 (PA+纤) 2L+2R 有内盖</p>
	<p>3-R35</p>  <p>L63*H63</p>	<p>R82</p>  <p>R36</p> <p>L83*H80</p>
<p>141轮壳 (PA+纤) 2L+2R 有内盖</p>	<p>T142轮壳 (PP)</p>	<p>T143轮壳 (PP) 2L+2R</p>

# 东莞市励骏高分子材料有限公司

## 轮壳目录

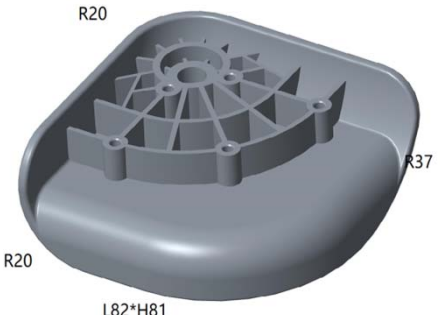
 <p>R20 R37 L82*H81</p>	 <p>R30 R35 L73*H73</p>	
<p>T144轮壳 (PP) 2L+2R</p>	<p>T145轮壳 (PP)</p>	<p>T146轮壳 (PP) 2L+2R</p>
 <p>R35 L72*H61</p>	 <p>R38.5 R40 L80*H80</p>	 <p>R20 R35 L79*H78</p>
<p>T147轮壳 (PP) 2L+2R 有内盖</p>	<p>T148轮壳 (PP) 有内盖</p>	<p>T149轮壳 (PP) 2L+2R 有内盖</p>
		
<p>ITO 60-1A轮壳 (PP)</p>	<p>ITO 60-1B轮壳 (PP)</p>	<p>ITO-2轮壳 (PP) R+L</p>

# 东莞市励骏高分子材料有限公司

## 轮壳目录

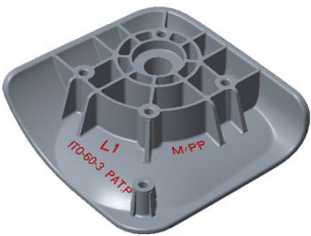
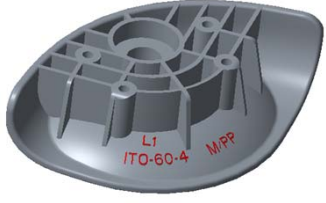
		
ITO-2B轮壳 (PP) 2L+2R	ITO-3轮壳(PP)R+L	ITO-4轮壳(PP)R+L